

MULTI-HANGER INLINE INSTRUCTION BULLETIN

MULTI-HANGER INLINE, ENGLISH

- 2 HANGER P/N 7-120, 120 VAC
- 2 HANGER P/N 7-145, 240 VAC
- 3 HANGER P/N 7-122, 120 VAC
- 3 HANGER P/N 7-146, 240 VAC
- 4 HANGER P/N 7-124, 120 VAC
- 4 HANGER P/N 7-147, 240 VAC

MINI MULTI-HANGER INLINE, ENGLISH

- 2 HANGER P/N 7-139, 120 VAC
- 2 HANGER P/N 7-148, 240 VAC
- 3 HANGER P/N 7-140, 120 VAC
- 3 HANGER P/N 7-149, 240 VAC
- 4 HANGER P/N 7-141, 120 VAC
- 4 HANGER P/N 7-150, 240 VAC

ADJUSTING THE VIBRATORY INLINE TRACK DRIVE TO ACHIEVE OPTIMUM FEED

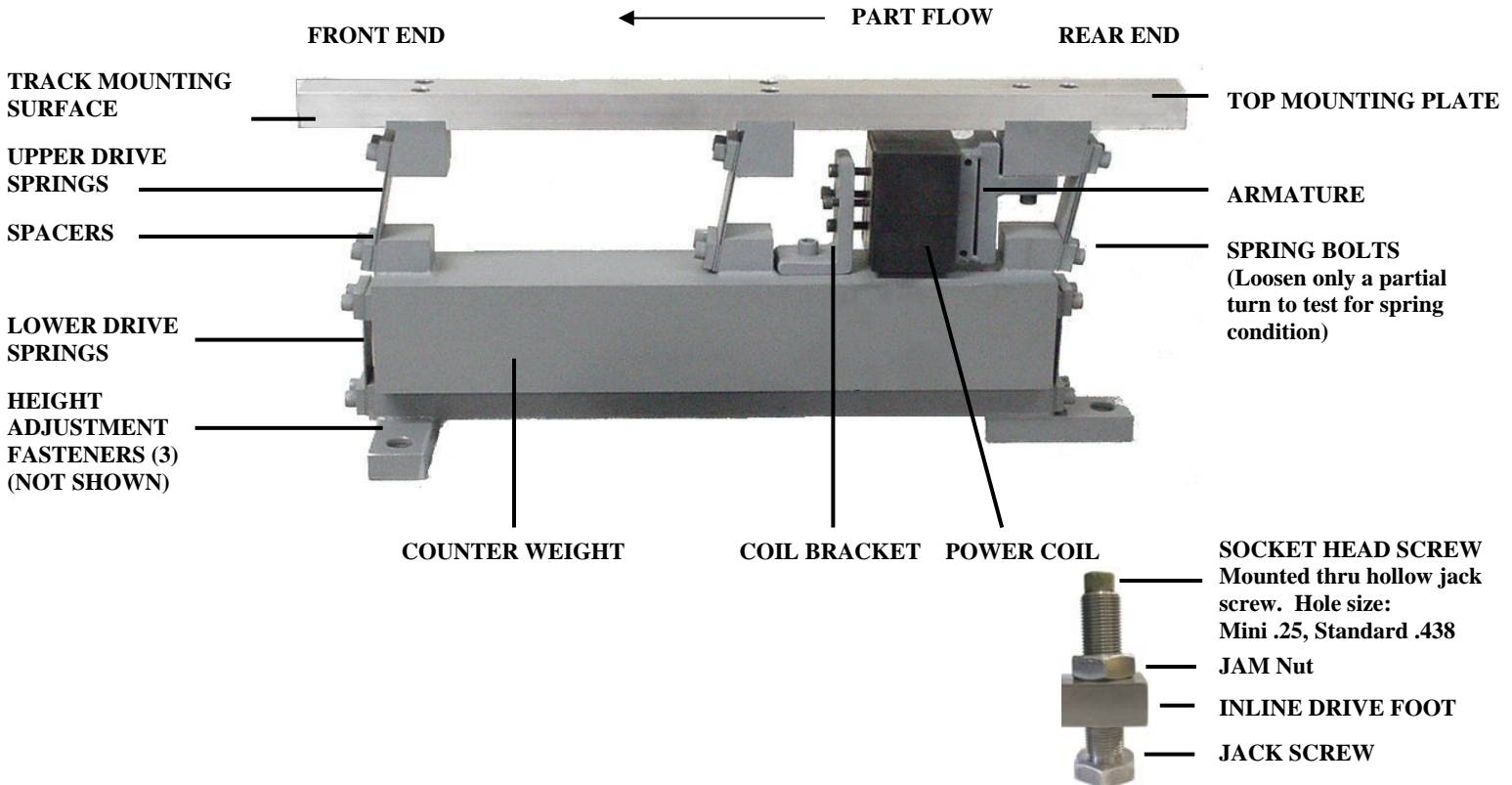

STARTUP REQUIREMENTS

Every factory supplied vibratory track inline drive must be tuned before placing it in service. Before tuning a vibratory track inline drive, check for the following startup requirements:

1. The drive must be mounted on a solid steel surface so that it is anchored to a rigid mass that will not absorb the vibration. If a riser is needed, the drive will operate on either a solid steel riser or a tube steel riser, however it may be easier to achieve the maximum feed rate when a solid steel riser is used.
2. The recommended track overhang on the Standard Inline is up to 10 inches in the front, and two inches in the back. The recommended track overhang on the Mini Inline is up to four inches in the front and one inch in the back. Try to keep most of the overhang in the front. It is advisable to stay within the recommended track length and weight specifications shown. See the drawings at the end of this document.

There are three variable inputs that must be adjusted in the following order to achieve the optimum feed rate with your RODIX Vibratory Inline Track Drive.

1. The gap between the armature and power coil.
2. The number of upper drive springs.
3. The setting of the vibration-amplitude dial on the vibratory feeder control.

NOTE: Changing the height of the jack screws can affect the tuning.

GAP SETTING

Loosen the coil bolt(s) so the coil can be moved by hand. Use feeler gages to set the gap between the armature and power coil. For the Multi-hanger Inline set the gap at .060 inch and never set the gap larger than .080". For the Mini Multi-hanger Inline set the gap at .030 inch and never set the gap larger than .060". Never set the gap less than .020 inch. The smaller the gap, the harder the parts will shake. During normal operation, don't allow the armature to hammer against the coil. Tighten the coil bolt(s) so the power coil will not move when operating. Make sure that the coil is parallel to the armature.

PULSE SETTING

Track drives tuned for 60 pps (pulses per second) are generally much easier to tune than 120 pps tracks. 60 pps tracks also use fewer springs. The 120 pps rate is used only for special applications such as with parts that tend to "shingle" in a feed track. Verify that the vibratory feeder control has been set to the correct pulse mode (60 or 120 pps) for your application.

NUMBER OF SPRINGS

The track should have a normal load of parts in place when testing to determine the correct number of drive springs required. Sometimes additional springs are needed from the factory to achieve proper tuning. If the parts do not move at all when the track drive control is turned **ON**, the drive is severely under-sprung. If the parts do nothing but bounce up and down when the control is turned **ON**, the drive is severely over-sprung. Locate the upper spring bolts at the rear of the counter weight. Loosening one of these two bolts has the equivalent effect as removing one spring. The rear springs have a larger effect on the tuning than the front springs do. Determine the tuned condition by slowly loosening only one bolt just a partial turn to break it free from its maximum torque, and observe the results. The lower springs should not be loosened or adjusted. Only the upper springs are changed during the tuning procedure. However for very heavy tracks, adding one spring to the lower front spring pack has the same effect as adding mass to the counter weight.

1. If the parts slow down suddenly, the drive is under-sprung. Correct this condition by adding one spring at a time to an upper spring bank, or by substituting a thicker spring in place of a thin one. Thicker springs are available from the factory. Keep the number of springs per bank within one spring of each other. Re-tighten the bolts and re-test the tuning every time a spring is added.
2. If the parts speed up suddenly, begin to bounce, or move backwards, the drive is over-sprung. Correct this condition by removing a spring from an upper spring bank or substitute a thinner spring in place of a thick one. Re-tighten the bolts and re-test the tuning every time a spring is removed.
3. If the parts speed up slightly at first and then slow down as the spring bolt is opened more, the track drive is operating correctly because it is slightly over-sprung. A slightly over sprung drive helps to provide a consistent feed rate when weight and voltage fluctuations occur.

NOTE: During the tuning process it is important to maintain the proper horizontal and vertical alignment of the springs, track, counter weight, and mounting feet.

When the Rodix Inline feeder control is set to the mid-power range in the slightly over-sprung condition, the parts should move forward at the optimum feed rate. There should also be enough amplitude control left in the upper power range for over-driving the parts. Then as the springs begin to age, there is enough of the control range remaining to turn up the control slightly and still maintain the optimum feed rate. If there is no movement of the parts in the feed track after continually removing springs until there is only one spring left on each (upper) hanger of the drive, close the coil gap down by .015 inch. If this fails, close the gap to .020 inch, but no less.

NOTE: The wider the gap, the more springs are required for proper operation.

After tuning the Inline feeder, monitor the coil temperature after 10 minutes of operation and during the first two continuous hours of operation. The coil should always be cool enough to touch with your hand; if it is too hot to hold, avoid coil failure by ensuring the proper tuning, reducing the coil gap, reducing the feeder control amplitude or retuning the feeder to draw less amperage.

PREVENTATIVE MAINTENANCE

The track tooling should be cleaned weekly. Denatured alcohol is commonly used for this purpose.

Clean the coil air gap quarterly with an appropriate thickness of shim stock. Don't remove the coil or change the air gap setting during cleaning.

POWER SETTING

For best results, the power setting on the inline's vibratory feeder control should be in the mid-range (about 60% – 80%) when the drive is feeding parts at the optimum rate. On a Rodix FC-70 or FC-75 control this is when the dial is set between 6-8. On other controls, this can be determined by connecting a voltmeter to the output of the control while the inline is plugged in. Measure the voltage at full power, then verify that the optimum rate is achieved at 60%-80% of full power.

PROBLEM SOLVING

Check for these problems if an inline drive is not operating properly:

1. Loose fasteners. All fasteners must be properly tightened to the recommended torque:
10-24 SHCS 5.5 foot pounds
5/16"-18 SHCS 27 foot pounds
3/8"-16 SHCS 59 foot pounds
2. Spacers between springs are missing or have become misaligned.
3. Gap between power coil and armature has changed, or the gap has foreign particles in it.
4. Inline's Vibratory Control should be set to 60 pulses per second, not 120 for most applications.
5. The track needs to be cleaned. Use denatured alcohol to clean it.
6. The parts may be contaminated or magnetized, or have excessive burrs.
7. Jack Screws must be properly leveled and the jam nuts must be tight.
1/2"-20 55 foot pounds
3/4"-16 193 foot pounds
8. The proper horizontal and vertical alignment of the springs, track, counter weight, and mounting feet must be maintained.
9. If two different inline track drives are mounted near each other, they may adversely vibrate each other. Minimize this interaction by increasing the mass of the machine table, use separate machine tables, or change the "60 pulse waveform reversal" setting on one of the Rodix feeder controls so that it operates on the opposite half of the sine wave. (Call Rodix for details).
10. If a dead spot on an inline track occurs, add extra spacers between an upper spring bank and its mounting block to eliminate the problem. If the slow spot is near the front end of the track, add spacers to the counter weight end of the front spring bank. If the slow spot is by the back end of the track, add spacers to the top plate end of the rear spring bank.
11. For a long inline part track that exceeds the normal capability of a track driver, use two or three track drives mounted in a long row on the same machine table. The rear drive should be a standard drive with a coil, and the other drive(s) may not need a coil.

For Sales, Service or Technical Assistance, please call:

RODIX, INC.
2316 23rd Ave., Rockford, IL 61104
Toll Free (800) 562-1868
E-mail custserve@rodix.com
FAX (815) 316-4701
www.rodix.com

Mini-Inline 2 Hanger

Models: 7-139 (120 Vac) & 7-148 (240 Vac)

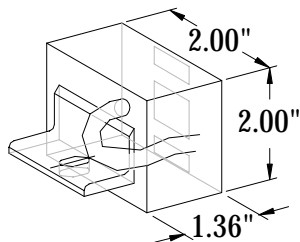

Mini Multi-Hanger Inline Coil

120 VAC = P/N 6-42-115

240 VAC = P/N 6-42-128

Coils:

120 VAC: P/N 6-42-115

240 VAC: P/N 6-42-128

Jack Screw: P/N 8-65-02

Springs:

Upper = P/N 90-3-56 = .020 Thk

Lower = P/N 90-3-57 = .032 Thk

Spacer: P/N 88-3-114

Drawing has no scale

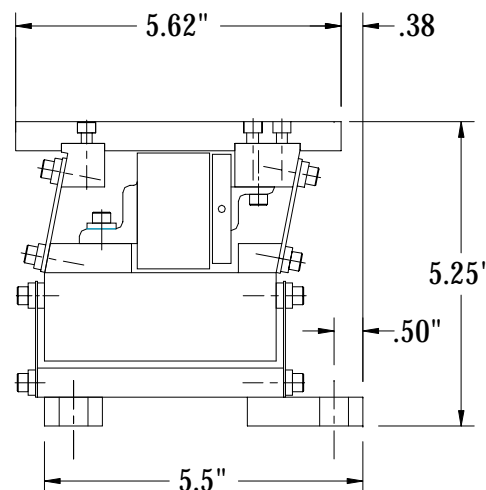
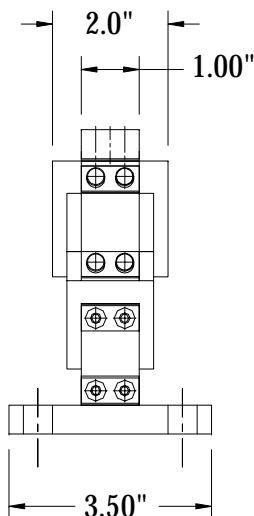
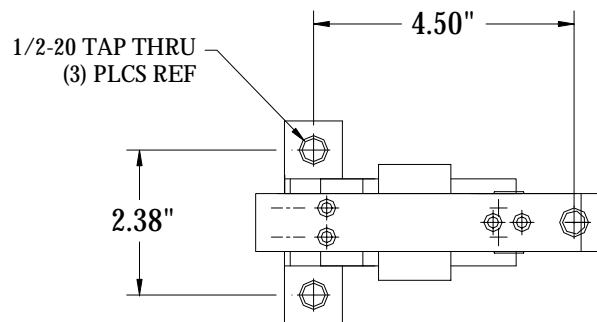

Models 7-139 & 7-148
Max Track Length: 10.75"

Track weight limitations: 3 pounds maximum
Height Adjustment Using Jack Screws: 5.875" to 7.25"
Electrical power: 7-139: 120 Volts, 50/60 Hz, .5 Amps
7-148: 240 Volts, 50/60 Hz, .25 Amps
Unit Weight 6 lbs



Rodix, Inc. 2316 23rd Ave
Rockford, IL 61104
Ph. (800) 562-1868 Fax (815) 316-4701
www.rodix.com