



## CONTROL PRODUCTS FOR INDUSTRY

### 3 CUBIC FOOT STANDARD VIBRATORY HOPPER

11 ga C.R.S. with Primed Finish, 120V Coil installed

P/N 026-500-0053

11 ga C.R.S. with Primed Finish, 240V Coil installed

P/N 026-550-0053

304 S.S. with Bead Blast Finish, 120V Coil installed

P/N 026-500-0058

304 S.S. with Bead Blast Finish, 240V Coil installed

P/N 026-550-0058

Our hoppers are manufactured using the finest materials and components and are delivered beautifully finished, assembled, and ready for installation.

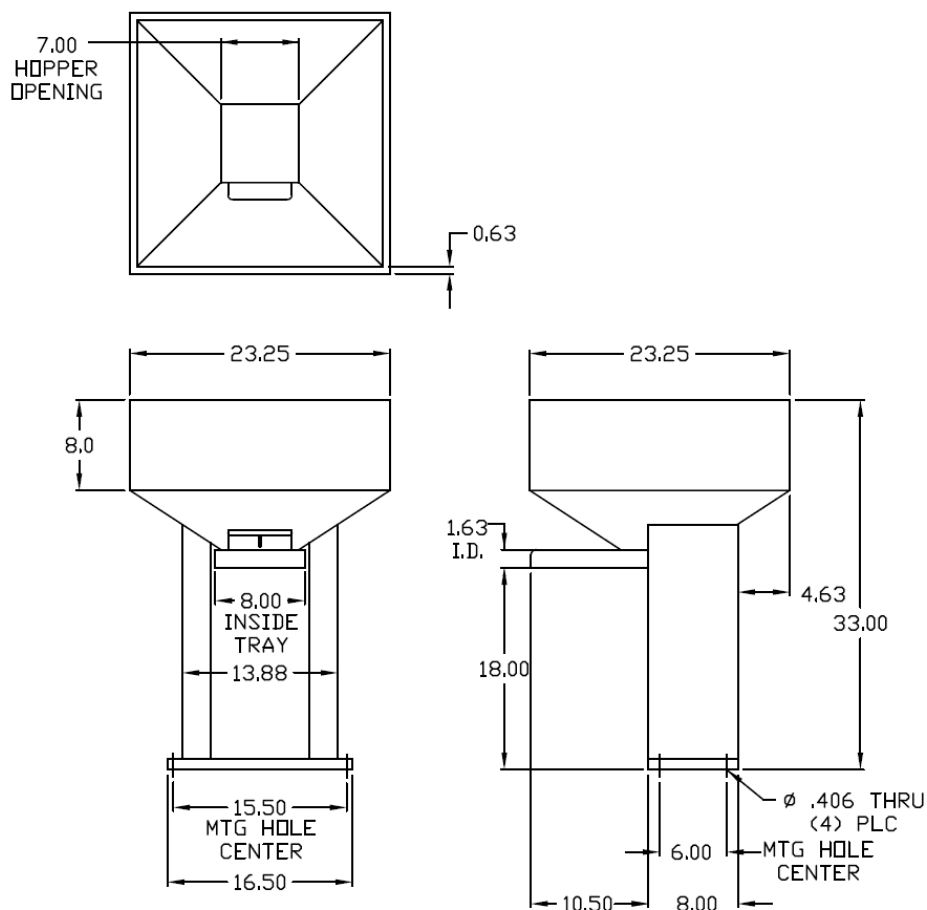

Dimensions are for reference only

Optional: Photoelectric Parts Level Sensor P/N [111-000-0521](#)

For special hopper sizes, styles, 316 SS or other special requests, please call or email today for a quote.  
Pricing is available by registering at [www.rodix.com](http://www.rodix.com)