



CONTROL PRODUCTS FOR INDUSTRY

6 CUBIC FOOT STRAIGHT FRONT VIBRATORY HOPPER

11 ga C.R.S. with Primed Finish, 120V Coil installed	P/N 026-500-0163
11 ga C.R.S. with Primed Finish, 240V Coil installed	P/N 026-550-0163
304 S.S. with Bead Blast Finish, 120V Coil installed	P/N 026-500-0165
304 S.S. with Bead Blast Finish, 240V Coil installed	P/N 026-550-0165

Our hoppers are manufactured using the finest materials and components and are delivered beautifully finished, assembled, and ready for installation.

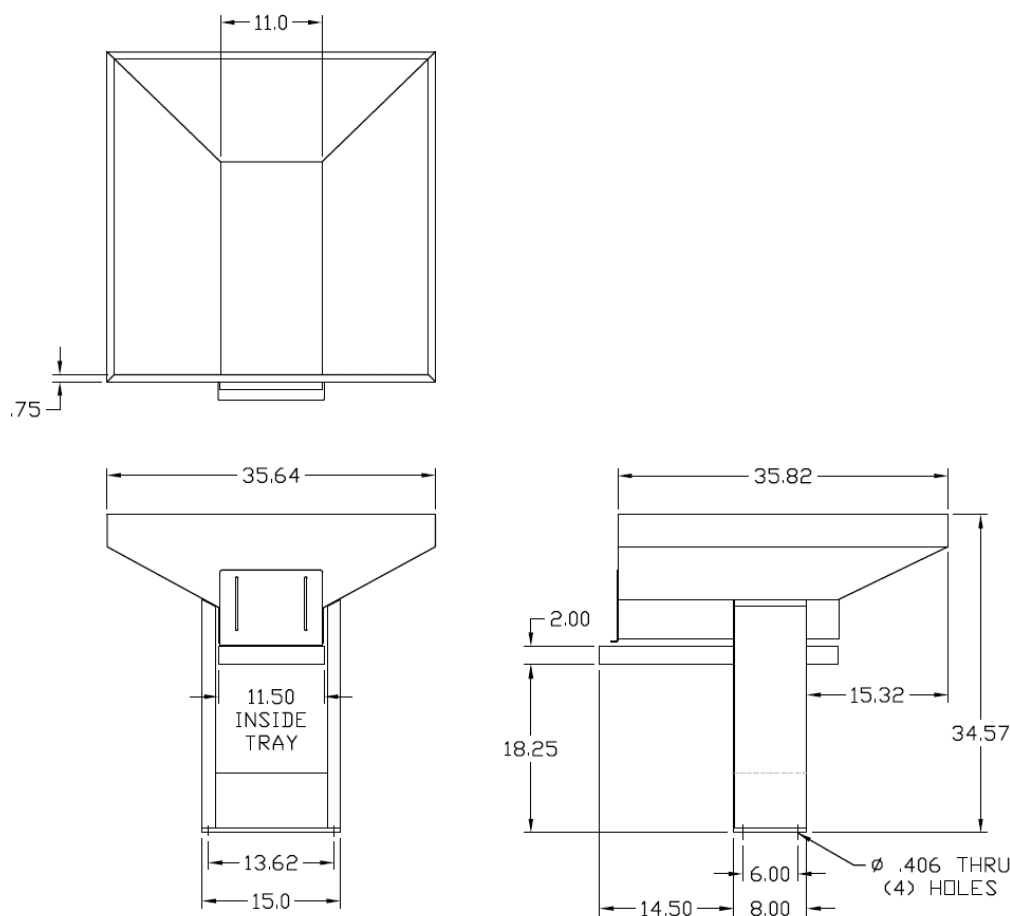

Dimensions are for reference only

Optional: Photoelectric Parts Level Sensor P/N [111-000-0521](#)

For special hopper sizes, styles, 316 SS or other special requests, please call or email today for a quote.
Pricing is available by registering at www.rodix.com