



RODIX INCORPORATED

2316 23rd Ave., ROCKFORD IL 61104
TOLL FREE (800) 562-1868, FAX (815) 316-4701
E-mail custserve@rodix.com
www.rodix.com

FEEDER CUBE®

CE-43 *Plus* General Purpose

OIL RESISTANT MODEL

IMPORTANT: APPLICATION NOTE

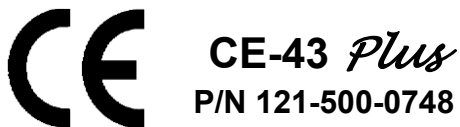

PRODUCT DESCRIPTION

This device is used to control the vibration levels of two vibratory feeder devices. Normally, Unit-A controls a feeder bowl, Unit-B controls either a vibratory inline or hopper. The units are powered from the incoming power line connection. Each unit has its own Master Control PC board. The setup and operation is detailed in the following product literature.

SPECIFICATIONS

Line Voltage: 120 VAC +/-10%
 Line Frequency: 50/60 Hz
 Current: 20A (Unit A: 15A; Unit B: 5A)
 Output Voltage: 0-120 VAC
 Handling & Transp. Temp. -40 – 60 °C
 Operating Temp. 0 – 40 °C

INSTALLATION

The control is to be firmly mounted to a non-vibrating surface. The control is designed to withstand conditions equal to IP54. Do not install the control in a more severe environment. Connections to external conduits or cords are to be made with hardware that is rated at IP54 or better.

Refer to the electrical wiring diagram. Line and load wiring is to be brought into the box via customer-drilled holes. Use 2.5mm² (#12 AWG) Mains supply wires or larger. Use 2.5mm² (#14AWG) load wires or larger for Units A & B. The Mains supply wires should be fused by the Customer at 20 Amps or less. After the wiring has been completed, verify the continuity of the ground bond connection to the control.

This control is for industrial use. Use in residential areas may cause interference, and in that case, special measures may have to be taken by the user regarding emissions.

IMPORTANT - The vibratory feeder must be tuned to match the power line frequency of the destination country (50 or 60 Hz). A feeder tuned to the wrong frequency will not feed parts. The Rodix control operates on 50 or 60 Hz.

SAFETY

When installing this control, a power supply disconnect device must be provided by the user. A power plug/socket combination can be utilized for this purpose. The plug and socket must have a breaking capacity of at least the amperage of the vibratory feeder(s).



Figure 1 – Warning label installed on the control

Warning – There is hazardous voltage inside the control. Disconnect power before opening the enclosure. Only skilled or instructed persons should open the enclosure.

An electrically instructed person is a person adequately advised or supervised by an electrically skilled person to enable him or her to perceive risks and to avoid hazards which electricity can create.

An Emergency stop device must be installed on the machine that incorporates the CE feeder control.

When the machine is installed, verify the continuity of the protective bonding circuit (earth ground) to the control.

PERIODIC INSPECTION AND FUNCTIONAL TESTING

When the control is operating normally, the output can be smoothly adjusted from zero to maximum by

the main control knob. If part sensors are used, the control starts and stops automatically according to the time delay settings on the circuit board. If soft-start is used, the output should start at zero and ramp up to the desired setting each time the control automatically starts.

The control should be kept reasonably free from dirt and contaminants that might inhibit proper cooling. No other planned maintenance is necessary.

MAINTENANCE

Normally no maintenance is needed for this control. If troubleshooting assistance is needed, either visit our web site at www.rodix.com, call RODIX: (international call) 815-316-4700x322 or (USA) 1-800-562-1868x322, FAX: 815-316-4701, or e-mail: custserve@rodix.com.

SPARE PARTS

Designation	Q	Rodix P/N	MFG P/N
Control Card	2	123-293*	
Fuse 15A 250V	1	106-18*	Bussman ABC15
OR			Littlefuse 314015
Fuse 5A 250V	1	106-21*	Bussman ABC5
			Littlefuse 314005
Fuse Holder	1	106-17	Littlefuse 354901GY
Triac	2	115-32*	
S1, S2 (DPST)	2	104-80*	
Switch Boot	2	104-26*	
Term. End 20A, 600V		264-301	Wago 264-301
Terminal Single 20A, 600V		264-321	Wago 264-321
Terminal Dual 20A, 600V		264-351	Wago 264-351
Knob		122-10	APEM 42011-3B-1/4

*Recommended spare parts to keep in stock.

© 2000, 2012 RODIX INC.

ADJUSTMENTS & SET UP for UNITS A & B

1. SELECT THE PULSE SETTING

Match the control's pulse mode to the feeder's tuning:

- A. For 60 pulse output - Set DIP switch (S1) to 60 on the circuit card.
- B. For 120 pulse output - Set DIP switch (S1) to 120 on the circuit card.
- C. For 40, 30 or 60 Reverse pulse settings, see the "S1 Programming Chart."

Note: Readjust the MAX trimpot after changing pulse switch setting.

2. LIMITING THE MAXIMUM OUTPUT OF CONTROL

The **MAX** output trimpot can be adjusted to limit the maximum vibration level of the vibratory feeder when the Main Control Dial is fully turned up. When setting up the MAX output of the feeder control, the output wiring to feeder must be connected and the control set for the proper pulse (60 or 120) setting. The Run Jumper must be connected as shown on the wiring diagram or on the ON/OFF Control Guide.

- A. Power input should be **OFF** or disconnected.
- B. Open cover to allow access to circuit card.
- C. Adjust the **MAX** Output trimpot counter-clockwise to its minimum setting.
- D. Using **CAUTION**, turn power **ON** (no output should be present).
- E. Rotate the **MAIN CONTROL DIAL** on front cover clockwise to its highest setting.
- F. Adjust the **MAX** Output trimpot so that the output to the feeder reaches its desired maximum level.

3. SETTING THE MINIMUM OUTPUT LEVEL OF CONTROL

When the vibratory feeder is nearly empty, turn the **MAIN CONTROL DIAL** to "1" and adjust the **MIN** trimpot to just below the slowest speed that provides the proper feed rate. The MIN trimpot also serves as the "low speed" trimpot for 2-speed operation. See "S1 Programming Chart" for feature selection details.

4. MAIN CONTROL DIAL

The output power is controlled by the **MAIN CONTROL DIAL**. It is a logarithmic-tapered power out curve (non-linear) that spreads the power broadly across the **MAIN CONTROL DIAL**. The logarithmic taper power curve helps to give maximum "Fine Control" over the output speed of the vibratory feeder. When very precise adjustment of the **MAIN CONTROL DIAL** is needed, increase the MIN trimpot setting and/or decrease the MAX trimpot setting. For precise scaling at low amplitudes, use the linear POT taper or reduce the Max pot setting. To select a linear pot taper for the Main Control Dial, see the "S1 Programming Chart."

5. SETTING THE SOFT-START

The start-up rate of the control output can be adjusted to ramp up to the desired output level instead of starting abruptly. Soft-start keeps parts from falling off the tooling, reduces spring shock, and hammering when the control turns ON. Turn the **SOFT** Start trimpot clockwise for the gentlest start (about a 6 sec. ramp up to full output). Turn the trimpot fully counter-clockwise for no soft start.

6. REMOTE OFF/ON CONTROL

A Run Jumper has been installed at the factory as shown on the enclosed wiring diagram.

Remote OFF/ON operation of the FC-40 *Plus Series* Feeder Cube® control can be configured to operate in one of the following ways.

- A. A **low current switch** such as a paddle switch can replace the factory-installed Run Jumper "J1." The "Run Contact" connects to terminals 6 and 7. The contact must be able to switch 5VDC and 2mA. The control will run only when the contact is closed. Refer to Section A of the OFF/ON CONTROL GUIDE.
- B. **Feeder Bowl/Hopper Interlock** allows the Hopper control to operate only when the Bowl is running and the paddle switch contact is closed. The **interlock input** on terminals 11 and 12 of TB2 is controlled by the **interlock output** of a "Parts Sensing Feeder Bowl Control" such as an FC-90 *Plus*

Remove jumper "J1" of this control from terminals 6 and 7. Connect the Hopper Paddle switch to alternate terminals 5 and 6. Connect TB2 terminals 11 and 12 of this control to the "Parts Sensing Control". Refer to Section B of the OFF/ON CONTROL GUIDE. Check specific instructions for the "Parts Sensing Control" wiring. Two FC-40 Series controls will not interlock to each other since neither one has an **interlock output**.

- C. **Low Voltage DC** can be used to turn the control **ON** and **OFF**. Move jumper "J1" from terminal 7, to terminal 5, (6 remains the same). Then connect the positive signal (+10 to 30VDC @ 10mA) to terminal 12 and the negative to terminal 11 of TB2. The control will now turn **ON** when the DC signal is present at terminals 11 and 12 of TB2. This input is optically isolated. Refer to Section C of the OFF/ON CONTROL GUIDE.

7. REMOTE SPEED CONTROL

Remote control of the power level can be accomplished by the following methods:

- A. 4-20mA signal from a PLC can be used to remotely vary the output of the control instead of the Main Control Dial. The 4-20mA input is automatically in control whenever a 4-20mA signal is applied to the control (terminals TB2-8 & 9). The Main Control dial setting is ignored whenever there is a 4-20mA signal. The 4-20mA input is transformer isolated from the power line. In an environment with high electrical noise, use a shielded cable for the 4-20mA signal. The "S1 Programming Chart" shows how change to 0-20mA speed control instead of the default of 4-20mA.
- B. A 0-5VDC Analog input signal may be applied in place of the Main Control Dial at H1. The 0-5VDC input is transformer isolated from the power line.

8. LINE VOLTAGE COMPENSATION

Fluctuations in the line voltage can cause a feeder bowl to vary its feed rate. The line voltage compensation feature adjusts the control's output to help compensate for fluctuations in the supply voltage. If it becomes necessary to disable this feature, set "Disable LVC" from the S1 programming chart.

9. SUPPLEMENTARY FEATURES

Special supplementary software features can be enabled on the 24-210/24-211 circuit boards. The features include: *linear pot taper*, *0-20mA control*, *empty bowl timer*, *low pulse rates*, and *two speed pots*. See the S1 Switch Programming Chart. For more feature information download (or request from RODIX) the FC-40 *Plus* Advanced Application Note 24-210/24-211.

10. STATUS LEDs

When any of the inputs are active, the associated LED will turn ON. When the RUN input conditions are met, the RUN LED will turn ON. See section 6 and the wiring diagram's ON/OFF Control Guide for more information on how to satisfy the RUN conditions.

WARNING:

Fuses should be replaced with a Bussman ABC or Littelfuse 3AB "Fast Acting" type or equivalent of manufacturer's original value.

Mounting this control on a vibrating surface will void the warranty.

WARRANTY

Rodix Control Products are Warranted to be free from defects in material and workmanship under normal use for a period of two years from date of shipment. For the full description of the warranty, terms, and software license, please contact the factory.

For assistance installing or operating your Rodix Feeder Cube® please call the factory or visit our web site. Technical help is available to answer your questions and fax any needed information. To return a control for IN or OUT of warranty service, please ship it prepaid to:

Rodix Inc., ATTN: Repair Department

If under warranty, Rodix will repair or replace your control at no charge; If out of warranty, we will repair it and you will be billed for the repair charges (Time and Material) plus the return freight. Quotes for repairs are available upon request. A brief note describing the symptoms helps our technicians address the issue.

Feeder Cube® is a registered TM of Rodix Inc.

S1 Programming Chart			
Program Description	S1 Switch Positions		
	SW3	SW4	SW5
Standard Program	0	0	0
Linear Pot Taper	1	0	0
0-20mA option	0	1	0
Empty Bowl Timer	1	1	0
Disable LVC	0	0	1
2-Speed Operation	1	0	1
30/40 Pulse Operation	0	1	1
Low Amplitude at "1"	1	1	1

TROUBLESHOOTING

For the control to run: The **MAIN CONTROL DIAL** must be turned up or have over 4mA at the 4-20mA input. Either the DIRECT LED must be lit or both the INTERLOCK and EXT VOLTS LEDs must be on. To light the DIRECT LED, connect a Run Jumper at TB2-6 & TB2-7. To light the INTERLOCK LED, a Run Jumper must connect TB2-5 to TB2-6. To illuminate the EXT VOLTS LED, TB2-11 & 12 needs a 10-30 VDC signal. See the "FC-40 Plus Troubleshooting Guide" for more information. If the feeder only hums, flip the 60/120 dip switch.

RODIX, INC.

2316 23rd Ave, Rockford, IL 61104
Toll Free (800) 562-1868, FAX (815) 316-4701
E-mail custserve@rodix.com
www.rodix.com

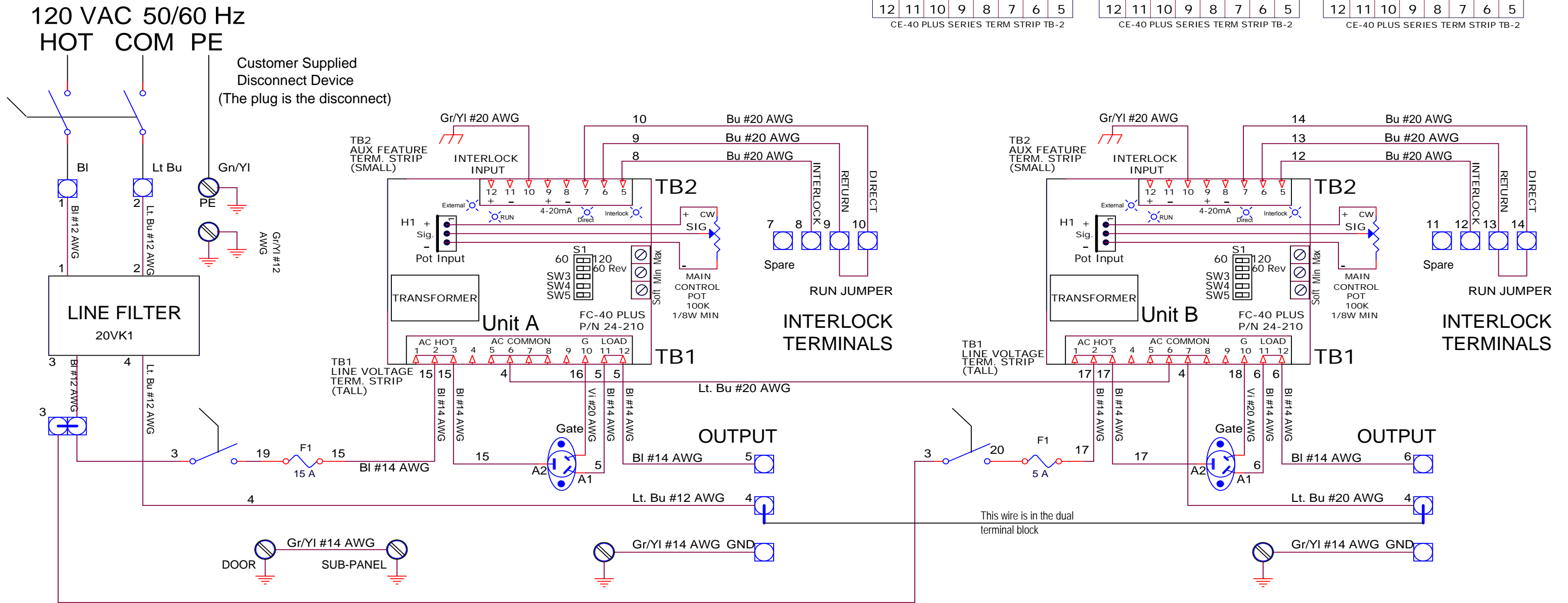

OFF/ON CONTROL GUIDE
P/N 123-293/123-294, 24-210/24-211

See section 6 of the Application Note for more details on the REMOTE OFF/ON CONTROL guide.

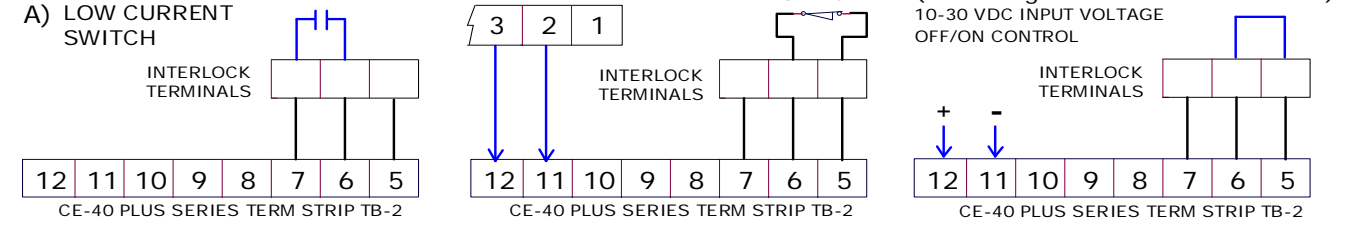

Caution: Disconnect power before opening enclosure

Installation instructions:
When installing this control, a power supply disconnect device must be provided by the user. A power plug/socket combination can be utilized for this purpose. The plug and socket must have a breaking capacity of at least the amperage of the vibratory feeder(s).

The size of the Mains supply wires should be 2.5mm² (#12 AWG) or larger.
The Mains supply wires should be fused by the Customer at 20 amps or less.

*** The common line is not fused in Europe. The common line should be fused for North American machine installations. Install the HOT & COM fuses external to the control, or install fuse(s) for each unit by cutting the common wire that goes from the switch to the terminal strip and add a fuse to it. Then apply wire number labels to the wire that connects to the switch.

CE-43 PLUS
P/N 121-500-0748
2/8/13 © 2000, 2013 RODIX INC

RODIX INCORPORATED
2316 23rd Avenue, ROCKFORD IL 61104
TOLL FREE (800) 562-1868, FAX (815) 316-4701
E-mail custserve@rodix.com
www.rodix.com



RODIX SOLUTION

Good wiring practices for avoiding electrical noise problems.

Rodix controls have been designed with a high degree of immunity to electrical noise; however, depending on the control installation, electrical noise can cause problems. These problems occur in less than 1% of the product installations. Most electrical noise problems can be avoided by following some simple guidelines. Good wiring practices need to be used to prevent electrical noise from interfering with your control's operation. Another name for electrical noise is Electro-Magnetic Interference (EMI).

Symptoms of Electrical Noise

The symptoms of electrical noise would appear as follows: a brief pause or a brief "bump" in the vibratory feeder's output that the control automatically recovers from. In rare cases the control will either stop operating or run continuously at full power in 120 pulse mode until the power switch is slowly cycled OFF and ON.

Sources of Electrical Noise

Electrical noise is generated by devices like relay coils, solenoid valves, contactors, servo motors, and variable

frequency inverter drives. The electrical noise is then transferred to another device by one of three ways. The noise could be conducted through the power wires, or capacitively coupled from wire to adjacent wire, or it is transmitted from the wires of a noise source.

Solutions for Electrical Noise

1. Use shielded wires for all I/O (Input / Output) signals. The I/O signals may include: 4-20mA input, Run input, Sensor input, 0-5VDC input, Interlock input or AUX output. The shield "drain" wire should be tied to the chassis in the Rodix control. The drain wire should be kept shorter than 2". Please see the enclosed picture.

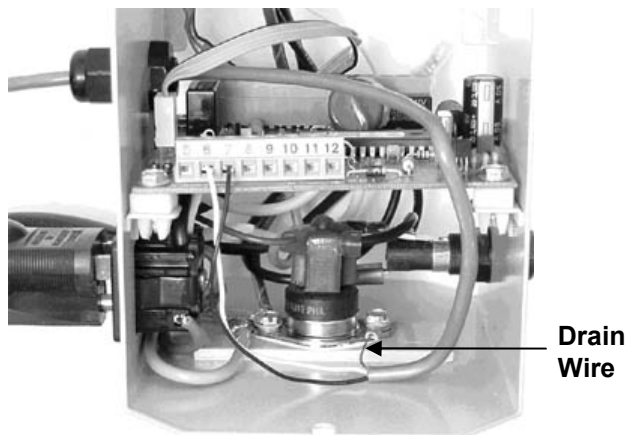

Example of a "drain" wire termination

2. Never run I/O signal wires in the same conduit or raceway as AC power lines such as wires to motors, solenoids, heaters, welders and Rodix controls, etc.

3. I/O wires within an enclosure should be routed as far away as possible from relays, solenoids, transformers, power wiring and other noisy equipment. Keep the I/O signal wires separate from the control's input and output power wiring. Secure the wires in place.

4. Whenever relays or solenoid valves are used, install a Snubber on them to reduce electrical noise. Use a diode on a DC coil. Use a RC Snubber on an AC coil.

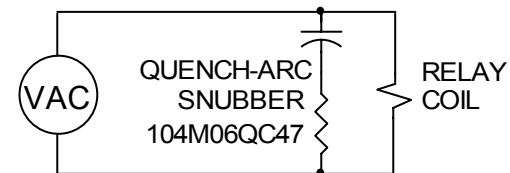
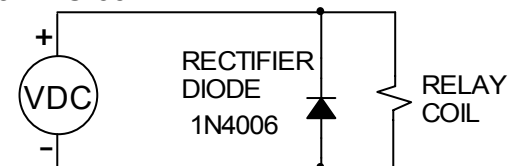

5. In extremely high EMI environments, Power Line Filters and ferrite beads can be effective. Install ferrite beads on I/O signal wires as close as possible to the circuit board terminal strip. Loop the wire through the bead several times or use several beads on each wire for additional protection.

RODIX, INC.

2316 23rd Avenue, Rockford, IL 61104
 Toll Free (800) 562-1868, FAX (815) 316-4701
 E-mail custserve@rodix.com
www.rodix.com

Declaration of Incorporation

We hereby declare that the following machinery is intended to be incorporated into other machinery, and must not be put into service until the relevant machinery into which it is to be incorporated has been declared in conformity with the essential requirements of the Machinery Directive, 2006/42/EC, and requirements of the Low Voltage Directive, 2006/95/EC.

BS EN 61326-1 Electrical equipment for measurement, control and laboratory use – EMC requirements

When using electrical equipment for control use, BS EN 61326-1 supercedes Electromagnetic Emissions EN 50081-2 and Electromagnetic Immunity EN 50082-2.

Safety of Machinery: EN 60204-1: 2006

Supplementary Information: Machine Safety Report Number – 98021628.J02
Machine Safety testing performed by:
Intertek Testing Services, 7435 4th Street North, Oakdale, MN 55128

EMC testing was performed by Rodix at:
L.F. Research, 12790 Route 76, Poplar Grove, IL 61065

Machine Description: Vibratory Feeder Control

Makes: CE-41 Plus, CE-41H Plus, CE-43 Plus, CE-43H Plus, CE-48, CE-48 Plus, CE-48H Plus, CE-49 Plus, CE-49H Plus, CE-91 Plus, CE-91H Plus, CE-91-2 Plus, CE-91-2H Plus, CE-91-3 Plus, CE-91-3H Plus, CE-93 Plus, CE-93H Plus, CE-98 Plus, CE-98H Plus, CE-98-2 Plus, CE-98-2H Plus, CE-98-3 Plus, CE-98-3H Plus, CE-99 Plus, CE-99H, CE-101 Plus, CE-101H Plus, CE-103 Plus, CE-103H Plus, CE-108 Plus, CE-108H Plus, CE-109 Plus, CE-109H Plus, CE-113 Plus, CE-113H Plus, CE-119 Plus, CE-119H Plus, CE-201 Plus, CE-201-2 Plus, CE201-3 Plus, CE-208 Plus, CE-208-2 Plus, CE-208-3 Plus, SPE-606, and SPE-890.

Types:

121-500-0606
121-500-0700 through 121-500-0703
121-500-0706 through 121-500-0721
121-500-0724 through 121-500-0736
121-500-0738 through 121-500-0792
121-500-0890

Manufactured by: Rodix, Inc.

A technical construction file for this equipment is retained at the following address:

2316 23rd Avenue, Rockford, Illinois 61104

Date: 7/27/2012
Title: Vice President

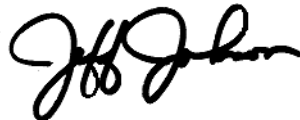
Signature: 
Name: Jeff Johnson

RODIX Inc.

CE restrictions for harmonic current emissions

Revised 5/3/2006

For vibratory feeder controls that have the CE mark, one of the many standards that the control needs to conform to is "Limits for harmonic current emission". The machine configuration will determine when to apply this standard.

International Standard IEC 61000-3-2 Effective 1/1/2001

Limits – Limits for harmonic current emissions (equipment input current \leq 16A per phase)

This part of IEC 61000 deals with the limitation of harmonic currents injected into the public low-voltage distribution system (electric utility). If the equipment input current exceeds 16A per phase, please refer to IEC 61000-3-4.

Harmonic currents can cause stress to the utility distribution system. It can stress the neutral of older wiring that doesn't conform to today's standards, and it can stress the utility transformers that are operating at their rated load.

When the standard does not apply:

This standard doesn't apply if the 230V machine is powered by a step down transformer.

The scope of the standard states:

IEC 61000-3-2 is applicable to electrical and electronic equipment having an input current up to and including 16A per phase, and intended to be connected to public low-voltage distribution systems.

Public low-voltage distribution systems are power supply systems allowing the direct connection of equipment with rated voltages between 200 and 260V (single phase) or between 340 and 450V (phase to phase). Higher voltage distribution systems, which are connected to power substations, are not considered to be public low-voltage systems.

A 230V machine with a vibratory feeder is typically powered by a step down transformer that is installed in a factory. Thus the machine is powered by a higher voltage distribution system that is not directly connected to the 230V public low-voltage system. Because of this, the machine is outside the scope of the standard¹.

When the standard does apply:

When a 230V machine is not powered by a step down transformer, there should not be a problem meeting this standard if all the vibratory feeders on one machine operate in the 100 Pulse (full wave) mode, and the combined total amperage for the vibratory feeders is 15 Amps or less. However it is harder to meet this standard in the 50 Pulse (half wave) mode. The combined total amperage for the vibratory feeders is limited to 3.5 Amps in the 50 Pulse mode when the machine is powered directly from the 230V public low voltage distribution system.

The vendor that supplies the finished machine is responsible for compliance to the applicable CE standards, not the end user. This vendor is responsible for performing the compliance testing on the finished machine.

Please note that EN61000-3-2 applies to 230V equipment. There are no limits for 120V equipment since these limits have not yet been defined; however, in Europe the 120V equipment will be connected to a step down transformer that might connect to the public 230V power mains. This means that 120V equipment that does not meet the harmonic current standard may cause a step down transformer that connects to the public 230V to fail to meet the harmonics standard.

50/100 Pulse – Alternate names:

The frequency of the utility power is 50Hz in Europe and 60Hz in the United States. Because of this, 50 Pulse mode in Europe is related to 60 pulse mode in the United States. 100 Pulse mode in Europe is related to 120 pulse mode in the United States. To change the pulse mode on the control, change the 60/120 switch. Listed below are some of the alternate names used to describe 60 pulse and 120 pulse:

<u>60 Pulses Per Sec.</u>	<u>120 Pulses Per Sec.</u>
R.C. or D.C.	A.C.
Rectified	Full Wave AC
Direct Current	Alternating Current
Half Wave	Full Wave
3600 Vibrations Per Min.	7200 Vibrations Per Min.

¹ From TUV Rheinland, FAQ

http://www.tuv.com/en/services/product_testing/all_types_of_products/electromagnetic_compatibility_services_emc/emc_faq.php

RODIX Inc.

CE notes about voltage fluctuations and flicker

What you need to know about the CE voltage fluctuations and flicker standard:

For machines that have the CE mark, one of the many standards that machine must conform to is the Limitation of voltage fluctuations and flicker. The machine configuration will determine when to apply this standard.

International Standard IEC 61000-3-3 Effective 1/1/2001

“Limits – Limitation of voltage fluctuations and flicker in low-voltage supply systems for equipment with rated current ≤ 16 amps per phase.” This part of IEC 61000 deals with the limitation of voltage fluctuations and flicker injected into the public low-voltage supply system (electric utility). When the amperage is over 16 amps, a companion standard, IEC 6100-3-11 is applied.

The limits in this standard are based mainly on the subjective severity of how much a 230V/60 W light bulb flickers when the supply voltage fluctuates. The frequent flickering of a light bulb can adversely affect some people.

When the standard does not apply:

This standard doesn't apply if the 230V machine is powered by a step down transformer.

The scope of the standard states:

IEC 61000-3-3 is applicable to electrical and electronic equipment having an input current up to and including 16A per phase, and intended to be connected to public low-voltage distribution systems of between 220V and 250V at 50Hz line to neutral.

Public low-voltage distribution systems are power supply systems allowing the direct connection of equipment with rated voltages between 200 and 260V (single phase) or between 340 and 450V (phase to phase). Higher voltage distribution systems, which are connected to power substations, are not considered to be public low-voltage systems.

A 230V machine with a vibratory feeder is typically powered by a step down transformer that is installed in a factory. Thus the machine is powered by a higher voltage distribution system that is not directly connected to the 230V public low-voltage system. Because of this, the machine is outside the scope of the standard¹. A machine that is connected to 60Hz power is also outside the scope of the standard.

When the standard does apply:

The standard is applicable when a 230V machine is powered directly from the 230V public low-voltage supply system.

The vendor that supplies the finished machine is responsible for compliance to the applicable CE standards, not the end user. This vendor is responsible for performing the compliance testing on the finished machine.

Please note that EN61000-3-3 applies to 230V equipment. There are no limits for 120V equipment since these limits have not yet been defined; however, in Europe the 120V equipment will be connected to a step down transformer that might connect to the public 230V power mains. This means that 120V equipment that does not meet the standard may cause a step down transformer that connects to the public 230V to fail to meet the standard.

What causes voltage fluctuations:

When an electrical load is turned on, it can cause the supply voltage to decrease a little bit due to the resistance and the inductance of the supply wires and step down transformer. The addition of a larger amp load causes a larger change to the supply voltage than a small amp load does. When the load turns off, the supply voltage rebounds back to the original value.

Disclaimer:

Standard EN61000-3-3 applies to the vibratory feeder system, and it does not apply to the vibratory feeder control. The amount of voltage fluctuations and flicker depends on how often the electrical load is turned On and Off by the machine and how large the load is.

¹ From TUV Rheinland, FAQ

http://www.jp.n.tuv.com/en/services/product_testing/all_types_of_products/electromagnetic_compatibility_services_emc/emc_faq.php

CE notes about voltage fluctuations and flicker continued

Guideline chart:

The chart provided here is not a substitute for a test. It is meant only to help determine when further review of standard EN61000-3-3 is needed. The chart does not cover every circumstance. Please note: if the machine is rated at 120 volts, or 60 Hz, this standard does not apply.

To use this chart, determine how many amps the machine uses during its normal operation. Is the amperage over 16 amps? Determine the amperage of the vibratory feeder when the feeder bowl (or hopper) is operating at its maximum feed rate with a full load of parts. Determine how often the vibratory feeder typically turns on and off. Compare the amps and on/off cycles to the chart.

For multiple vibratory feeders only add their amperage together if they always start and stop at the same time. Actual testing may prove that the number of On/Off cycles shown in the chart can nearly be doubled when the Soft Start pot is adjusted for a one second (or longer) soft start.

Amps rms at 230V	Maximum On/Off cycles permitted
16	1 On/Off cycle per 6 minutes
15	1 On/Off cycle per 4.5 minutes
14	1 On/Off cycle per 3 minutes
13	1 On/Off cycle per 3 minutes
12	1 On/Off cycle per 3 minutes
11	1 On/Off cycle per 3 minutes
10	1 On/Off cycle per 1.5 minutes
9	1 On/Off cycle per 1 minute
8	1 On/Off cycle per 1 minute
7	1 1/3 On/Off cycles per 1 minute
6	2 On/Off cycles per 1 minute
5	6.5 On/Off cycles per 1 minute
4	19 On/Off cycles per 1 minute
3	65 On/Off cycles per 1 minute
2	195 On/Off cycles per 1 minute
1	Unlimited On/Off cycles per 1 minute

This chart is based on Rectangular voltage changes at equal intervals using the Pst=1 chart, fig. 4 of standard EN61000-3-3. $P_{lt} = P_{st} \times 0.65$